

Panel mounted receptacle

Part no. 1151A



- screw terminals
- X-CONTACT®
- 20° inclination
- products with pilot contact on request

Technical specifications

Ampere	63 A
Poles	4 p
Voltage	400 V
Clock position	6 h
Hertz	50-60 Hz
Connection technology	Screw terminals
Contact	highly heat resistant contact carrier, X-CONTACT®
Protection type	IP 44
Flange	110x106 mm
Fixing hole	85x77 mm
Inclination	20 °
Weight	569 g
Declaration of Conformity	VDE, EAC, CQC

Drawing

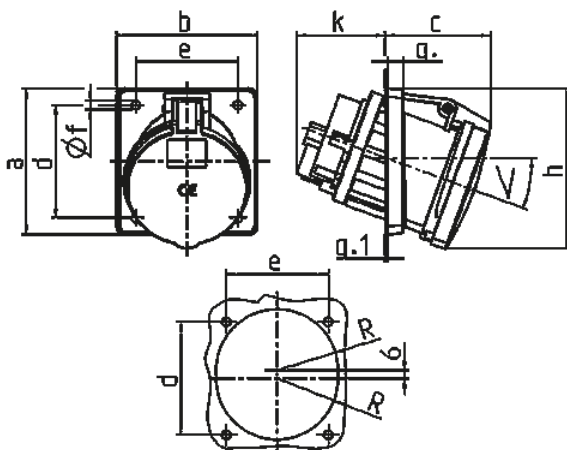

Drawing	Amp.	63		
		Poles		
1 MB 297		3	4	5
Dim. in mm	a	110	110	110
	b	106	106	106
	c	82	82	82
	d	85	85	85
	e	77	77	77
	f	6.5	6.5	6.5
	g	12	12	12
	g.1	2	2	2
	h	122	122	122
	k	69	69	69
	R	46	46	46
	α	20°	20°	20°
Terminal for cond. cross section (mm ²) min.-max.		6 -25	6 -25	6 -25