

Wall mounted receptacle DUOi R

Part Number.: 5814506TC



MENNEKES

Elektrotechnik GmbH & Co. KG
Aloys-Mennekes-Straße 1
57399 KIRCHHUNDEM GERMANY
www.MENNEKES.org

Product Description

- screw terminals
- LED voltage indicator
- pre-wired for installation
- X-CONTACT
- highly resistant to chemicals
- mechanical DUO-interlock
- switched
- highly heat resistant contact carrier
- nickel plated contacts
- switched N conductor, with auxiliary contact switch 2 NC and 2 NO
- receptacles can be padlocked
- sealed against dust, temporary submersion and high pressure cleaning
- enclosure base with pre-marked drilling points for custom cable entry drilling

Technical Details

Wall mounted receptacle - DUO	5814506TC
Product series	DUOi R
Switch Disconnecter	Yes
Ampere	32A
Number of Poles	5p
Clock position	6h
Voltage	400V
Hertz	50-60 Hz
Current Type	AC
Switch Type	3P + N' + PE + 2NC + 2NO
Protection Type	IP67/IP69
Impact resistance	IK08
Contact carrier	Nickel-plated contacts Highly heat resistant
Pilot contact	Without pilot contact

Connection	Screw-terminals
LED voltage indicator	Yes
Padlocked	Yes
Mounting method	Wall mounted
Cable entry	Top & bottom (without cable entry openings) 2 x M25 top or bottom closed 1 x M25 and 1 x M32 top or bottom closed
Weight (net)	1454 g
EAN / identification number	4015394306641

Permissible ambient conditions

Permanent ambient temperature min. - max.	from -25°C to +40°C °C
---	------------------------

Material properties

Hinged lid	PA6/TPE similar RAL 3013 red similar RAL 9005 black
Upper enclosure part	PC/SI similar RAL 7001 silver grey
Enclosure base	PC/SI similar RAL 9005 black
Rotary Switch	PC/SI similar RAL 7001 silver grey
Material of exterior screws	PA6 similar RAL 9005 black

Material resistance

The material resistance overview can be found on the website in the "Knowledge" section → "Product knowledge" → "Materials"

Regulations and Standards

RoHS 2011/65/EU incl. 2015/863/EU	✓
POP Regulation (EU) 2019/1021	✓
Norm(s)	IEC 60309-4
Declaration of conformity	CE
Test mark	-

Dimensional drawing

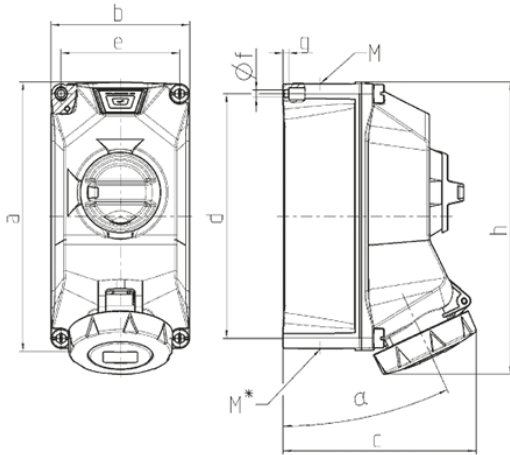

Drawing 1 MB 716 Dim. in mm	Amp. Poles	16			32		
		3	4	5	3	4	5
a		225	225	225	225	225	225
b		118	118	118	118	118	118
c		163	163	165	168	168	169
d		208	208	208	208	208	208
e		101	101	101	101	101	101
f		6.4	6.4	6.4	6.4	6.4	6.4
g		5	5	5	5	5	5
h		241	245	249	252	252	255
α			25			25	
M		1x25 and 1x32			1x25 and 1x32		
M*		2x25	2x25	2x25	2x25	2x25	2x25
Max. cable diam. (mm)		25	25	25	25	25	25
Terminal for cond. cross section (mm ²) min.-max.		2.5	2.5	2.5	2.5	2.5	2.5
		-10	-10	-10	-10	-10	-10